

Guidelines

O.H door blanks and panels

Content:

Page:	Guidelines door blanks
4	Storage and handling
5	Sealing of cut outs
6-8	Installation of glass/panels
9-13	Stiles and rails
14	Tolerances
15-16	Type of veneer facing
17-18	Machining and groove depth
19	How to repair
20-23	Surface treatment and maintenance
24	Bolection Mould
25	Rain Deflector
Page:	Guidelines panels
27	Surface treatment MDF panels
28	Installation MDF panels
29	Expansion of laminated timber
30	How to use laminated timber
31	HDF panels

Dear Customer,

Thank you for choosing O.H. Industri A/S as your supplier of door blanks.

These Guidelines have been prepared by us as assistance and guidance to you regarding the handling, application, surface treatment and use of our door blank products in connection to your manufacture and sale of external doors.

These Guidelines are based on our general experience regarding the manufacture of doors by the use of our door blank products. However, your use of our products shall always take into consideration the specific application in your doors. **Therefore, O.H. Industri A/S does not accept any liability that these Guidelines are complete or is directly applicable for your specific application.**

The mentioning in these Guidelines of specific materials or components from specific suppliers (such as paint, screws, glue etc.) are examples only. **You as purchaser of our products have the responsibility to diligently check whether the use of the mentioned materials/components for your doors is feasible, including whether such materials/components legally can be used in the countries where you intend to manufacture or sell your doors.**

We hope that you find these Guidelines helpful. If we can be of further assistance, please do not hesitate to contact us or visit our website: www.oh-industri.com. Downloads available on website includes; product data sheets, technical drawings and video guidelines

O.H. Industri A/S

Guidelines **Door blanks**

Inspect the pallets and doors for visible defects

Storage and handling

- Upon receipt of delivery of door blanks, inspect the pallets and each door for any visible defects.
- Visible defects must at once be informed to O.H. Industry and be added to the consignment note.
- Door blanks should be stored on a flat and level surface in a dry, well-ventilated building.
- Cover to keep clean and keep out sunlight, but allow air circulation.
- Handle with clean gloves and do not drag door blanks across one another or across other surfaces.
- Door blanks should not be subject to: abnormal heat, extreme dryness, humid conditions or sudden changes therein. They should be conditioned to average prevailing relative humidity of the locality before processing and hanging.

- It is very important to seal all cut outs in a door with a sealer to avoid water to get into the construction.
- Seal the inside and outside of the construction with e.g. a water based acrylic sealer.

Examples;

- Door knocker
- Letter slot
- Kicking plate
- Spy hole
- Nail/screw holes

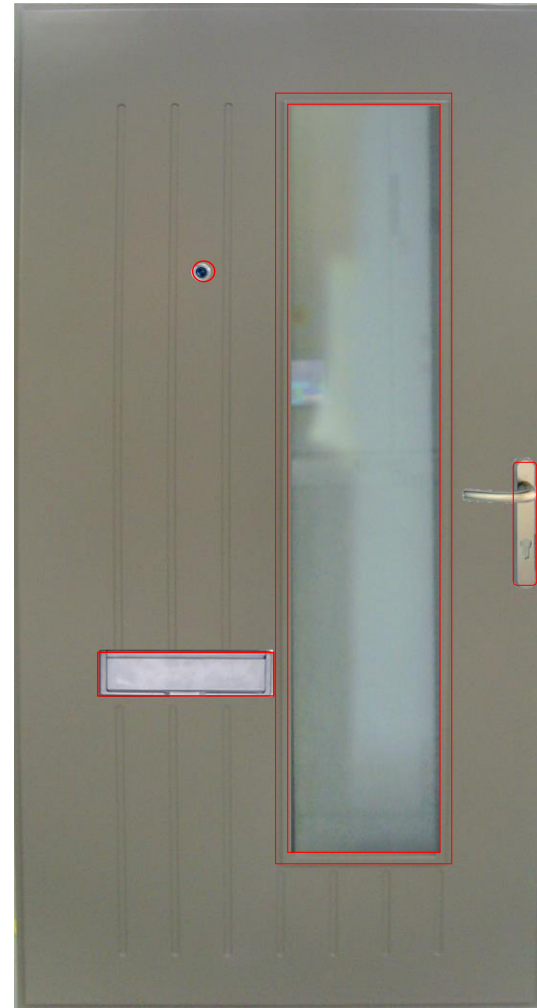

- Use alu tape or similar in bottom of cut out to avoid moisture to get into the core.
- After the installation of the glass or panel the glazing cassettes shall be sealed on the external side as well as sealed inside the construction.
- In connection to the sealing it is important that the drain holes in the bottom glass cassettes are not sealed.
- **Type of sealer;**
 - Outside; e.g. Dana Lim 509 Acrylic Clear; single component rubbery acrylic dispersion, fully transparent
 - coatable
 - treated against mould.
 - Inside; e.g. Dana Lim 524 Sealant; elastic adhesive glue

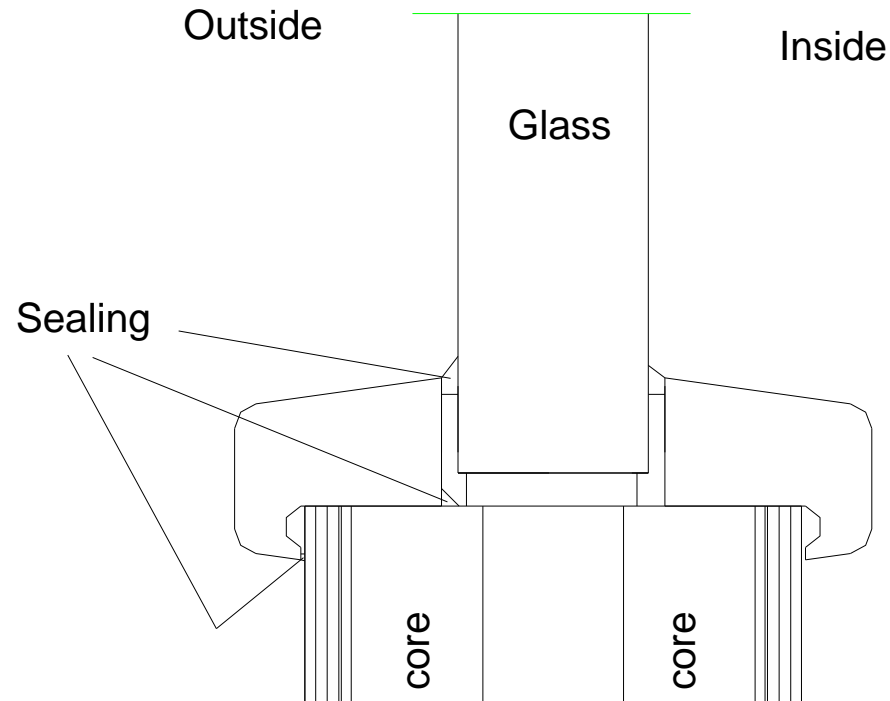

Installation of glass or panel - with timber block

Step 1

- Cut out in the door
- Remove insulation

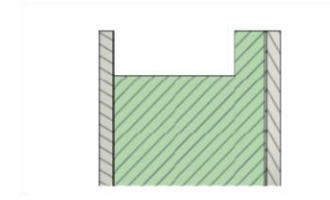
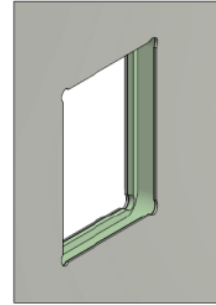

Step 2

- Install timber frame around the cut out
- Use glue for fixing the timber frame

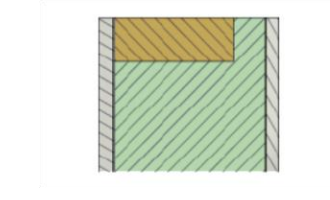
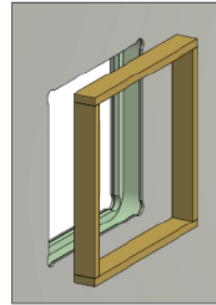

Step 3

- Put aluminium tape or similar in the bottom of the cut out to avoid moisture to get into the core.

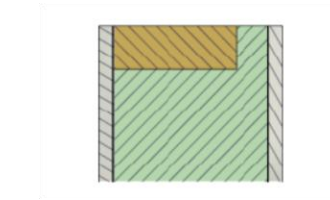
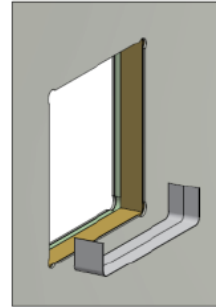

Step 4

- The glazing cassettes shall be sealed on the external side as well as sealed inside the construction.

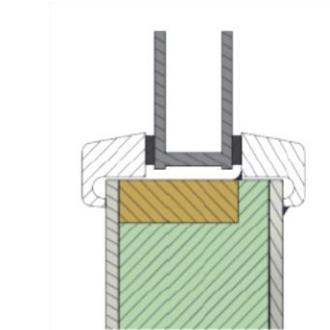
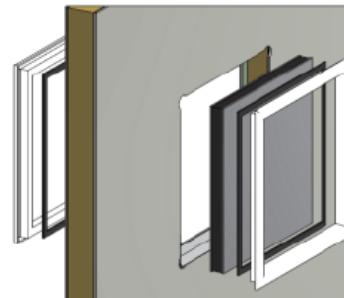

**Option 1
Timber block**

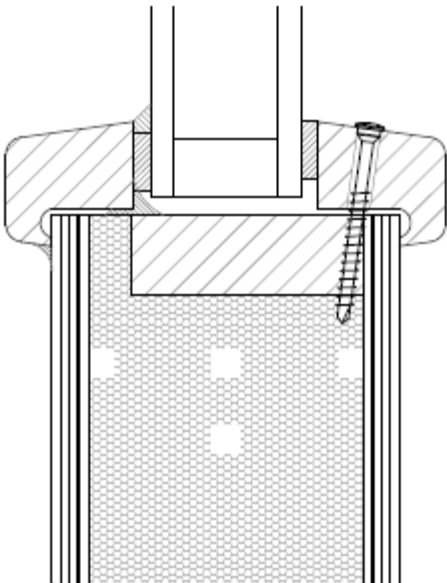

**Option 2
Ply inlay 9 mm**

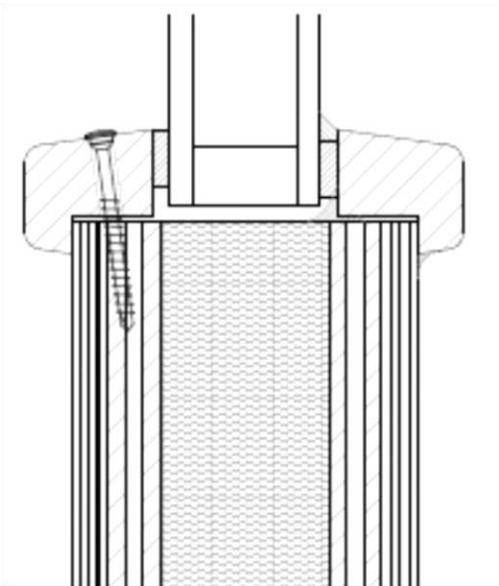

**Option 3
(Only HPL door)**

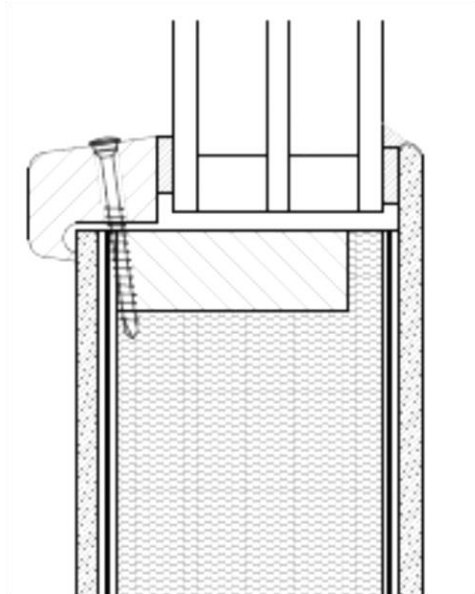

OH cut out Type 20:

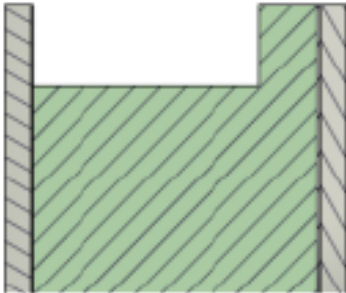

OH cut out Type 30:

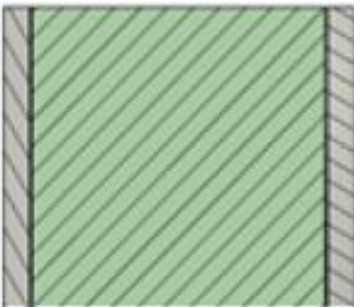

OH cut out Type 40:

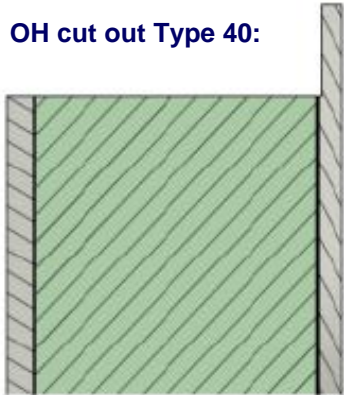

Door blank – Standard with timber lock block

- Timber lock block both sides
- Long timber lock block in full door length is an option
- Steel nails in the corner
- Be aware of steel nails when machining / profiling doors
- The steel nails in the corners is for fixing the stiles and rails in the production process before gluing the facing on the door frame.
- The stability in the door comes from the timber frame, the glue joints and the cross banded veneer facing with aluminium.

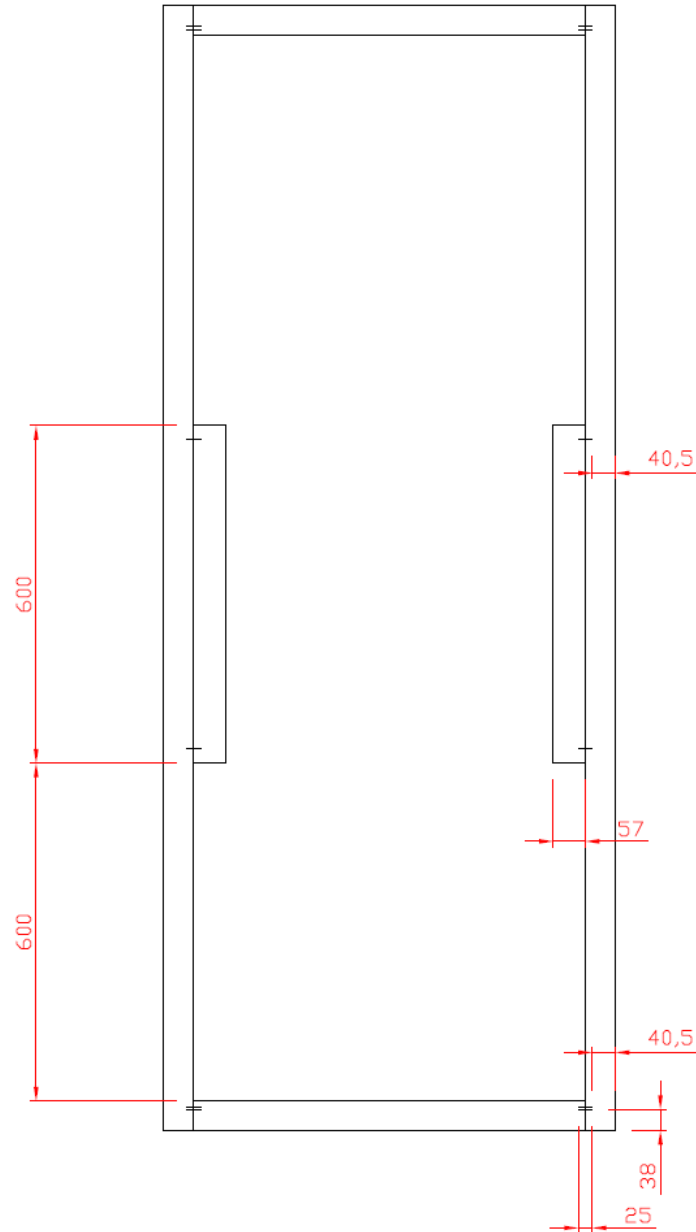

- Long timber lock block in full door length is an option
- 110 mm stiles/rails is an option on all door types.
- Stiles/Rails is finger joint A-quality pine timber.
- Timber lock block is knotted D-quality pine timber.

**55 mm stiles/rails
Std lock block**

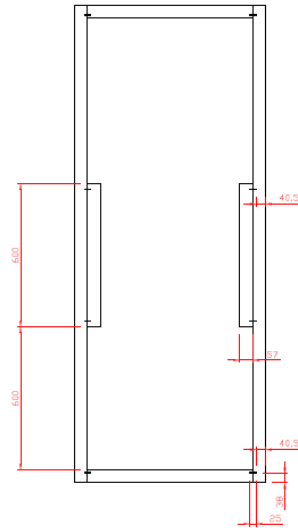

**55 mm stiles/rails
Long lock block**

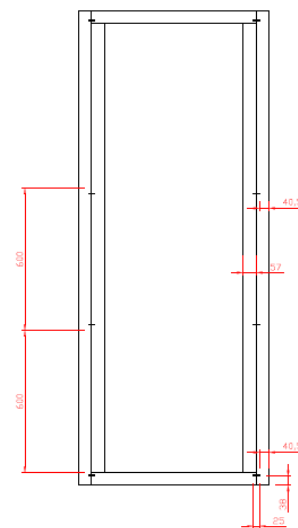

**110 mm stiles/rails
No lock block**

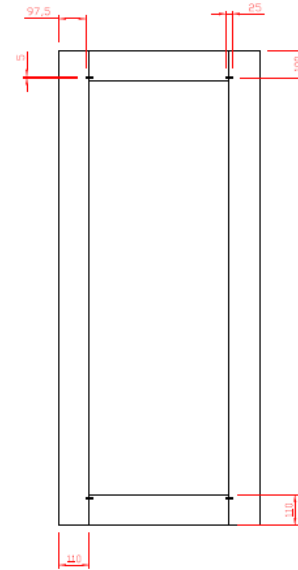

**110 mm stiles/rails
Long lock block**

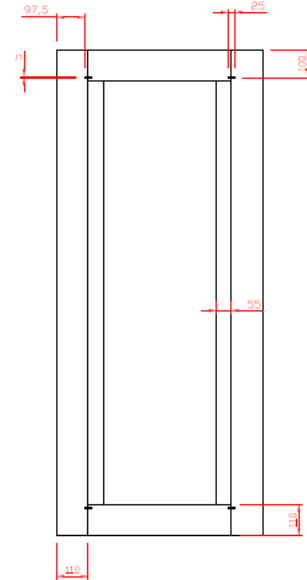

Doors with 110 mm stiles/rails can be trimmed 60 mm on all sides and top/bottom.

Specification Quality A:

- Nots, cracks, resin pockets and blue stain are not allowed

Specification Quality D:

- Nots, cracks, resin pockets are allowed
- Blue stain are not allowed.

Machining timber stiles/rails:

- When machining the timber stiles/rails hidden quality errors can be visible and must be repaired with e.g. plastic wood or glue.

Hidden quality errors in pine finger joint glued timber to be repaired (not accepted as a claim) includes:

- wind cracks (max. length 100 mm)
- resin pockets (max. length 50 mm)
- black nots (max. Ø15 mm)
- fresh nots (max. Ø25 mm)
- pith (max. length 100 mm).

Door blanks 110 mm stiles/rails

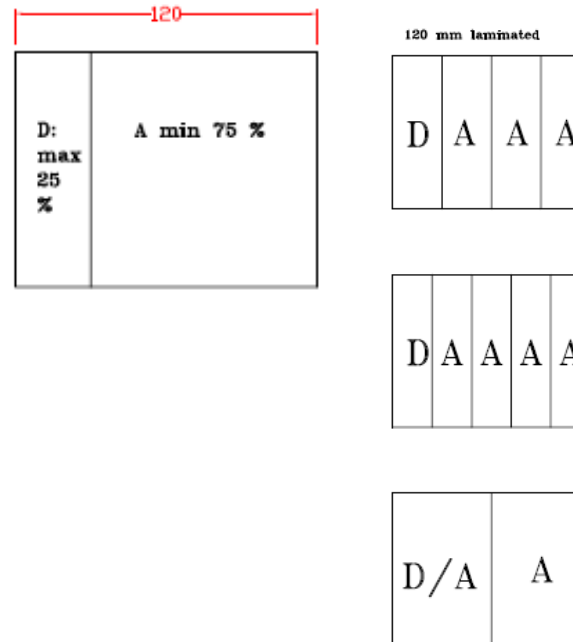

Door blanks 55 mm stiles/rails

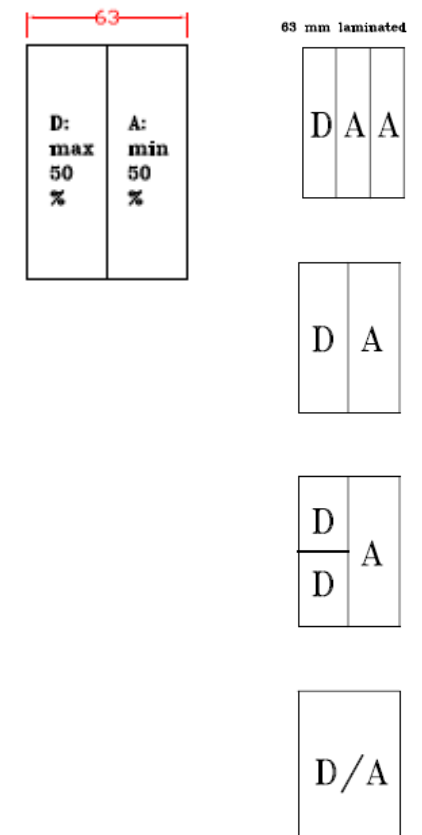

- **Important:** When trimming the door blank the stiles/rails must be minimum 50 mm to have full stability in the door.
- When machining/profiling the door be aware of the depth of the profile/rebate.
- It is recommended to have minimum 25 mm timber in the bottom of the profile.

Profil type 1

Use a door blank with 110 mm stiles/rails

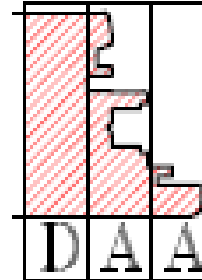

Profil type 2

Use a door blank with 55 mm stiles/rails

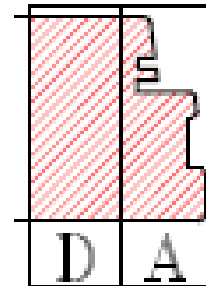

Door blank – Special with extra stiles/rails

- Available as 44 mm door and 58 mm
- Only available in standard door sizes.

- 150 mm stiles knotted pine
- 240 mm rails knotted pine
- Can be trimmed 100 mm each side and 200 mm in top/bottom

- Steel nails in the corner

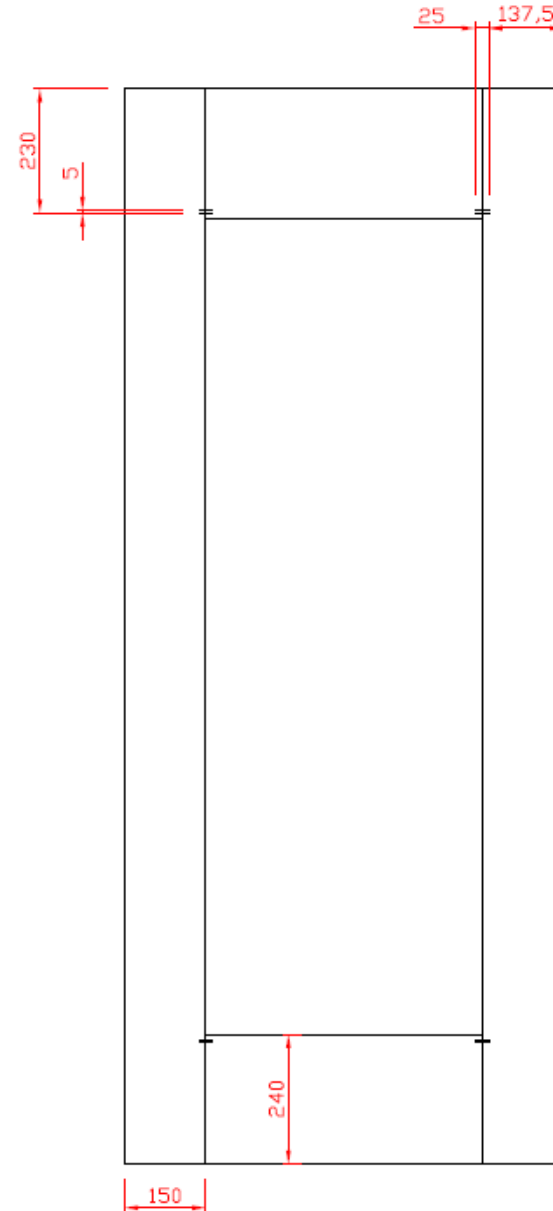

Tolerances door blank;

- Thickness: $\pm 0,8$ mm
- Diagonal: $\pm 2,0$ mm
- Length/Width: $\pm 1,0$ mm

- The standard OH door blank with 55 mm stiles and rails is climate tested at the IFT Rosenheim laboratory in Germany and meets the highest climate class (class 3: bowing less than 2 mm on door length).

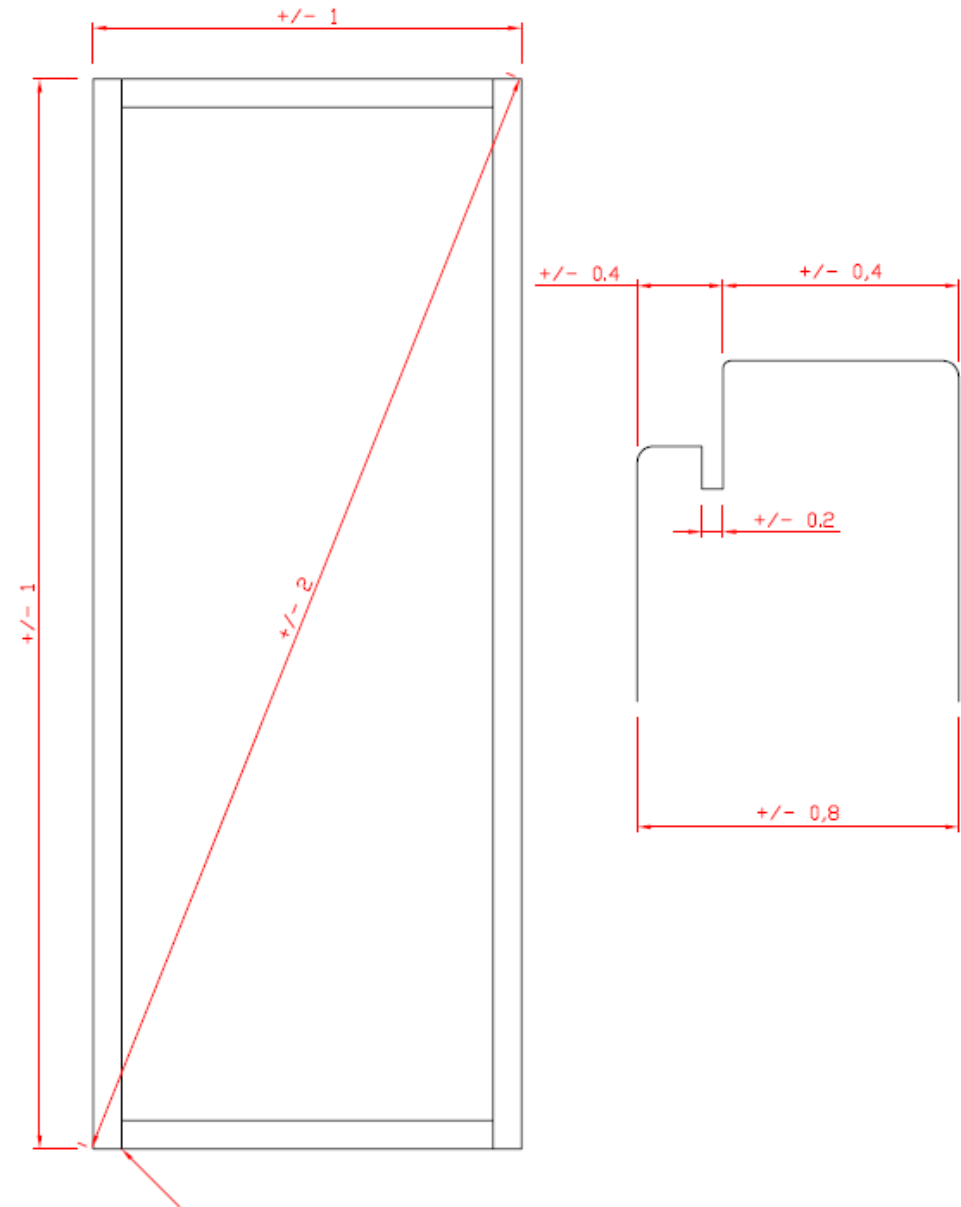

- **When ordering door blanks be aware of quality and type of veneer facing:**

- For paint colours
- For stain colours
- For grooves

Veneer facing for paint colours:

- Quarter cut sliced veneer and slip matched joined
- Typical properties of the wood with less regular structure and with colour nuances
- Larger nots in veneer surface and small dark knots is allowed
- Repair with wood filler in veneer surface is allowed

Veneer facing for stain/transluscent colours:

- Quarter cut sliced veneer and slip matched joined
- Pure wood veneer with regular structure and slight colour variations
- Small nots in veneer surface, but no dark knots is allowed
- Small errors in veneer surface is repaired

Veneer facing for grooves (paint or stain):

- With high quality veneer also in 3rd layer

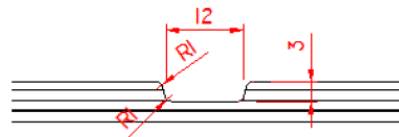

Option to select high quality veneer in 3rd layer for better finish in the bottom of the groove

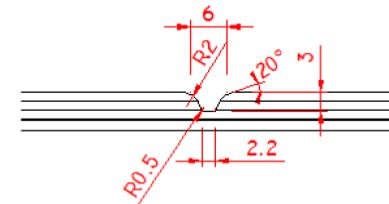

No need to select high quality veneer in 3rd layer due to the profile in the bottom of the groove

- **OH are using ChenChen veneer facing on doors for paint and stain colours**
- ChenChen veneer is a durable material for exterior doors, which has been proven over many years in the Nordic countries.

ChenChen veneer:

- Origin: Africa (grows throughout the high forest zones of West, Central and East Africa)
- Latin name: *Antiaris toxicaria* (of the Family Moraceae)
- Other names: Chen Chen, Blonde Sapele, White sapele, Ako, kyenkyen, quen, bark cloth tree, ako, mkuzu, mlulu, oro, ogiovu, kirundo, mumuka, upus, adoum, bonkonko, false iroko
- Eco labels: limited availability of FSC
- Density: 250-540 kg/m³ (lightweight hardwood)

Properties of ChenChen veneer:

- Chen Chen is also referred to as white sapele because it has a nice ribbony-grain pattern similar to the ribbon stripe in sapele. Chen Chen is a cleaner wood than Sapele, because it doesn't have the pin knots that sapele can have.
- Light-colored wood, ranging from a white yellow to yellow brown with no distinction between its sapwood and heartwood
- Can be stained and finished well. It is easy to go from dark to light. Visible wooden structure when painted. Can be stained with a veneer-like appearance of oak, mahogany, etc.
- Is a durable material for exterior doors, which has been proven over many years in the Nordic countries.

Quality on OH ChenChen door:

- Quarter cut sliced veneer and slip matched joined
- Typical properties of the wood with less regular structure and with colour nuances
- Larger nots in veneer surface and small dark knots is allowed
- Repair with wood filler in veneer surface is allowed

- **Maximum groove depth;**
- Veneer door: 3,0 mm
- HDF door: 2,2 mm
- HPL door: 2,2 mm

4 layers of veneer

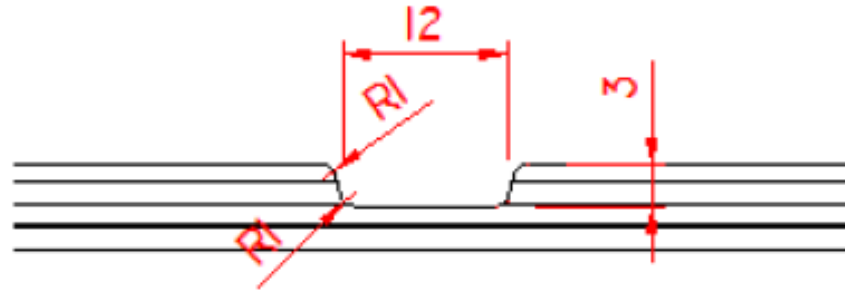

HDF and HPL

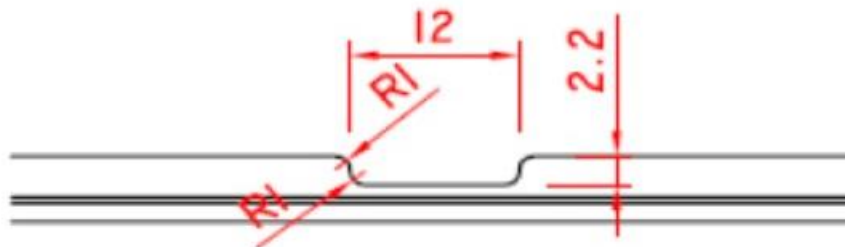

- **Maximum groove depth;**

- Veneer door: 3,0 mm
- HDF door: 2,2 mm
- HPL door: 2,2 mm

To achieve the best quality in the groove we recommend;

- Radius on the edges of the groove and in the bottom of the groove
- No vertical groove sides, but small slope on groove sides
- Optimise tool specification and tool speed (rpm) for the specific CNC machine type

Type 20 (12 x 3 mm)
4 layers of veneer

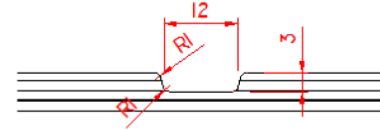

Type 20 (12 x 2,2 mm) - (12 x 1,5 mm)
HDF and HPL

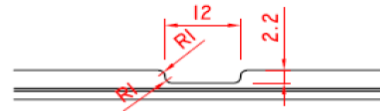

Type 40 (6 x 3,0 mm)
4 layers of veneer

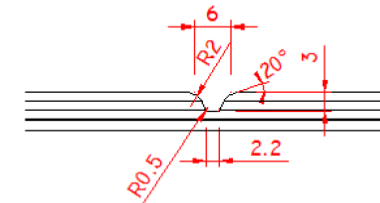

Type 50 (28 x 2,2 mm) - (12 x 1,5 mm)
HDF (2,2 mm) and HPL (1,5 mm)

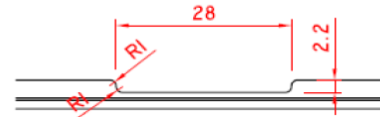

Type 50 (28 x 3 mm)
4 layers of veneer

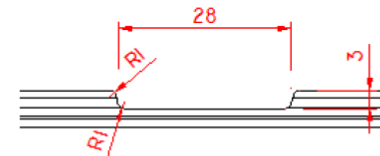

Openings in veneer surface

- If damage is < 1 mm; use e.g. water based light weight filler
- (e.g. Dana Lim 628 Light weight filler)
- If damage is > 1 mm; use e.g. two component wood filler

Damages on stiles/rails

- Use e.g. two component woodfiller

- **Important:** Never close openings between stiles and rails in the bottom of the door. It's important to allow humidity to get out of the construction !

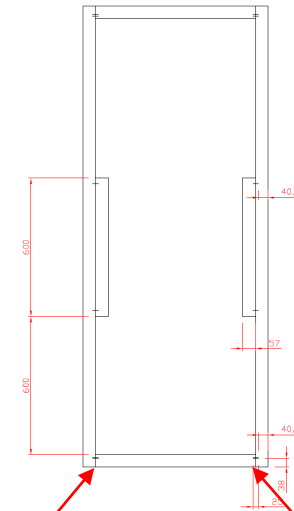

Before finishing

- Before finishing, remove handling marks or effects of exposure to moisture with a thorough final sanding over all surfaces of the door
- Always sand in the direction of the grain. Use sandpaper grain 150-180 (P150-P180).
- The door has been presanded in factory with grain 150-180 (P150-P180).
- For the best finish sand the surface with grain 180 between primer and topcoat when using waterbased paint system.
- **Important: Make sure the door has room temperature when applying the paint !**
- Painting a cold veneer door increase the risk of air bubbles in the paint surface, due to cold air from the veneer structure will go out when the door temperature increase going through the flash off zone and drying zone in the paint line.
- Also, a very high temperature and very low relative humidity in the drying zone can result in bubbles due to the drying proces does not allow humidity to get out before the paint film has hardened.

Paint system

- Before installation of the door, use a suitable paint system for external use. Never install an untreated door.
- For improved durability and finish in the grooves, prime the grooves with e.g. a paint brush before priming the full door.
- It is recommended to use a paint system with fungicides in both primer and topcoat.
- **Contact your paint supplier for more guidance on paint systems !**

- After painting the door, close the joining between stiles and rails in the top of the door with a sealer to avoid water to get into the construction.
- Use a flexible sealer that can absorb the movement in the timber over time to maintain the long term durability of the door.
- Use the sealer after painting to allow the fungicides in the painting system to be absorbed in the timber joining.

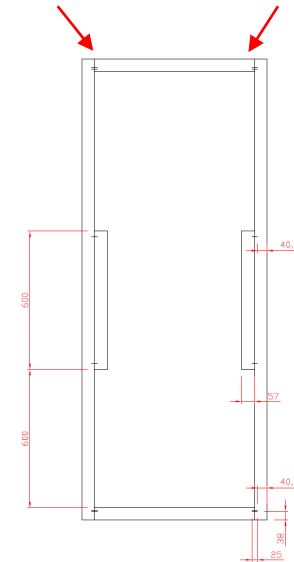

- **Important:** Never close openings in the joining between stiles and rails in the bottom of the door. It's important to allow humidity to get out of the construction !

Inspection

Maintenance a few times a year extends the lifetime of your doors !

- Inspect regularly to see if there are cracks emerging in the exterior coating and for damages on the door edge/corners.
- This applies particularly on the southern and western elevations, bay-parties, etc. where the sun's UV rays are hard on all woodwork. Also houses without eaves are exposed. Doors painted in dark colours, placed in coast areas or in direct sun is more exposed. Just one crack in the paint exposes the timber to moisture, and the decomposition of the timber has begun.
- Pay extra attention to the glazing beads on doors with glass apertures and on the lower part of the door which is extra exposed.

Maintenance and cleaning

- The doors must be reviewed once a year with a brush to make repairs to the surface wherever it is needed. For post-treatment we recommended the use of a paint with great covering power either water or oil based in the appropriate colour.
- Furthermore it is a good idea to wash the door a few times a year. It removes dirt and other contamination, which ultimately degrades the surface. Use water with a mild detergent.
- When the timber surface is to be cleaned, it is a good idea also to have a look for any small cracks and crevices in the paint surface. Generally, when the weather begins to discolour the paint on your doors, it is time for maintenance.

- **Important:** Dark colours will become significantly warmer than light colours and this makes maintenance more frequent necessary.
- Dark colours take up a lot of heat from the sunlight and it will affect the stability of the veneers. The paint will become less flexible during time. It will become brittle and eventually the paint will burst.
- Cracks in paint and cracks in the veneer on doors, painted with colours in class 3 are not accepted as claims.

Recommended maintenance schedule:

- Colour class 1 and 2: Inspect yearly and repaint after 5 years.
- Colour class 3: Inspect yearly and repaint after 2 years if exposed to direct sun or extreme conditions.

RAL Colours Colour Class Classification

Series	Color	Colorclass	
1000 series White	1013 Pearl white	13	
	1014 Ivory	19	
	1015 Light ivory	15	
1000 series Yellow/Beige	1000 Green beige	23	
	1001 Beige	25	
	1002 Sand yellow	26	
	1003 Signal yellow	24	
	1004 Gold yellow	27	
	1005 Honey yellow	31	
	1006 Corn yellow	29	
	1007 Chromate yellow	29	
	1011 Brown beige	34	
	1012 Lemon yellow	25	
	1016 Sulfur yellow	13	
	1017 Saffron yellow	23	
1018 Zinc yellow	17		
1019 Grey beige	33		
1020 Olive yellow	33		
1021 Cadmium yellow	21		
1023 Traffic yellow	21		
1024 Ocher yellow	32		
1027 Curry yellow	35		
1028 Melon yellow	24		
1032 Broom yellow	26		
1033 Dahlia yellow	26		
1034 Pastel yellow	26		
2000 series Orange	2000 Yellow orange	34	
	2001 Red orange	39	
	2002 Blood orange	40	
	2003 Pastel orange	30	
	2004 Bright orange	35	
	2008 Lightred orange	33	
	2009 Traffic orange	36	
	2010 Signal orange	36	
	2011 Deep orange	33	
	2012 Salmon orange	35	
	3000 series Red	3000 Fire red	42
		3001 Signal red	42
3002 Carmine red		42	
3003 Ruby red		43	
3004 Purple red		44	
3005 Wine red		44	
3007 Black red		45	
3009 Oxide red		44	
3011 Brown red		44	
3012 Beige red		32	
3013 Tomato red		42	
3014 Old pink		34	
3015 Light pink	26		
3016 Coral red	41		
3017 Pink	37		
3018 Strawberry red	38		
3020 Traffic red	41		
3022 Salmon red	35		
3027 Raspberry red	41		
3031 Orient red	41		
4000 series Purple	4001 Red purple	39	
	4002 Red violet	42	
	4003 Erica violet	36	
	4004 Bordeaux violet	44	
	4005 Blue violet	38	
	4006 Traffic purple	41	
	4007 Purple violet	45	
	4008 Signal violet	41	
	4009 Pastel violet	34	
	4010 Tele magenta	39	
	5000 series Blue	5000 Violet blue	43
		5001 Green blue	43
5002 Ultramarine blue		44	
5003 Sapphire blue		45	
5004 Black blue		45	
5005 Signal blue		43	
5007 Brilliant blue		40	
5008 Grey blue		44	
5009 Azure blue		42	
5010 Gentian blue		43	
5011 Steel blue		45	
5012 Light blue		36	
5013 Cobalt blue	45		
5014 Pigeon blue	37		
5015 Sky blue	38		
5017 Traffic blue	42		
5018 Turquoise blue	37		
5019 Capri blue	42		
5020 Ocean blue	44		
5021 Water blue	40		
5022 Night blue	40		
5023 Horizon blue	40		
5024 Pastel blue	34		
6000 series Green	6000 Patina green	39	
	6001 Emerald green	41	
	6002 Leaf green	42	
	6003 Olive green	42	
	6004 Blue green	44	
	6005 Moss green	44	
	6006 Olive grey	44	
	6007 Bottle green	45	
	6008 Brown green	45	
	6009 Spruce green	45	
	6010 Grass green	40	
	6011 Reseda green	38	
6012 Black green	44		
6013 Reed green	38		
6014 Olive yellow	44		
6015 Olive black	44		
6016 Turquoise green	41		
6017 Spring green	38		
6018 Yellow green	34		
6019 White green	19		
6020 Chromium oxide green	44		
6021 Bleach green	32		
6022 Olive brown	45		
6024 Traffic green	38		
6025 Fern green	40		
6026 Opal green	43		
6027 Light green	26		
6028 Pine green	43		
6029 Mint green	41		
6032 Signal green	39		
6033 Mint turquoise	37		
6034 Pastel turquoise	29		
7000 series Grey	7000 Squirrel grey	35	
	7001 Silver grey	32	
	7002 Olive grey	37	
	7003 Moss grey	38	
	7004 Signal grey	31	
	7005 Mouse grey	39	
	7006 Beige grey	39	
	7008 Kaki grey	40	
	7009 Green grey	41	
	7010 Tent grey	41	
	7011 Steel grey	42	
	7012 Basalt grey	41	
7013 Brown grey	42		
7015 Slate grey	42		
7016 Hard coal grey	44		
7021 Black grey	43		
7022 Amber grey	45		
7023 Concrete grey	36		
7024 Graphite grey	43		
7026 Granite grey	44		
7030 Stone grey	33		
7031 Blue grey	40		
7032 Pebble grey	26		
7033 Cement grey	36		
7034 Yellow grey	34		
7035 Light grey	19		
7036 Platinum grey	32		
7037 Dust grey	36		
7038 Agate grey	26		
7039 Quartz grey	40		
7040 Window blue	30		
7042 Traffic grey A	33		
7043 Traffic grey B	42		
7044 Silk grey	25		
7045 Tele grey 1	33		
7046 Tele grey 2	35		
7047 Tele grey 4	19		
8000 series Brown	8000 Green brown	39	
	8001 Ocher brown	38	
	8002 Signal brown	42	
	8003 Loam brown	41	
	8004 Copper brown	41	
	8007 Deer brown	43	
	8008 Olive brown	42	
	8011 Nut brown	44	
	8012 Red brown	44	
	8014 Septa brown	44	
	8015 Chestnut brown	44	
	8016 Mahoni brown	44	
8017 Chocolate brown	45		
8019 Grey brown	44		
8022 Black brown	45		
8023 Orange brown	39		
8024 Beige brown	41		
8025 Bleach brown	41		
8028 Terra brown	44		
9000 series White	9001 Cream white	11	
	9002 Grey white	15	
	9003 Signal white	7	
	9010 Bright white	7	
	9016 Traffic white	6	
	9018 Papyrus white	19	
	9000 series Black	9004 Signal black	45
		9005 Deep black	45
9011 Graphite black		45	
9017 Traffic black		45	

Installation of Q-Wood composite profiles “Bolection Mould” - to create in-depth design

- Use Q-Wood composite profiles “Bolection Mould” to make a traditional door style
- Available as standard profile

Advantages:

- Cost effective compared to Raised&Fielded panels
- High thermal efficiency

Unspecified tolerances:
All dimensions are in millimeters
unless otherwise stated,
Unspecified Radii 0.2mm

Holes +/- .1mm
Angles +/- .5 Deg
Radii +/- .2mm

No. Dec Places +/- .5mm
1 Dec Place +/- .2mm
2 Dec Places +/- .1mm

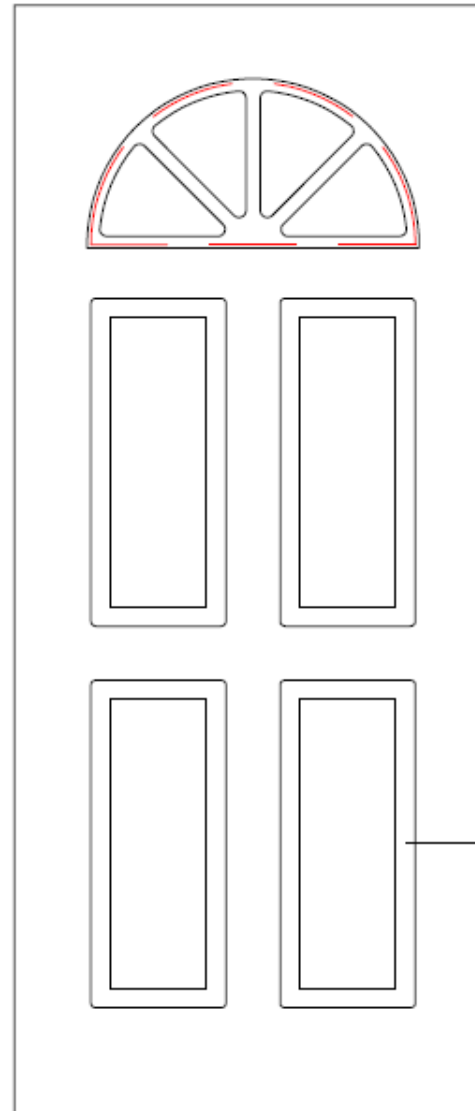
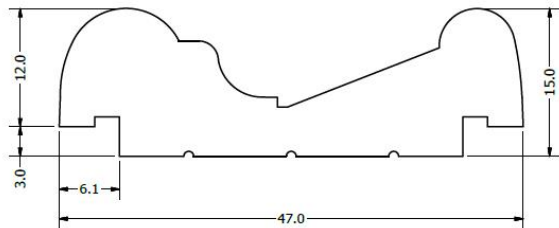
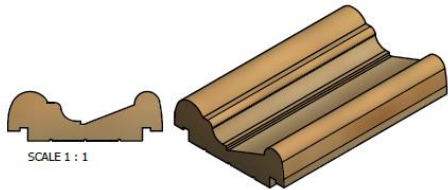

- Select a Rain Deflector that effectively leads the water away from the bottom of the door
- Minimum 5 mm air between the door facing and the Rain Deflector is required to allow water drops to fall off.
- When mounting a kicking plate or rain deflector seal the top and all nail/screw holes with a sealer to avoid water to get into the construction.

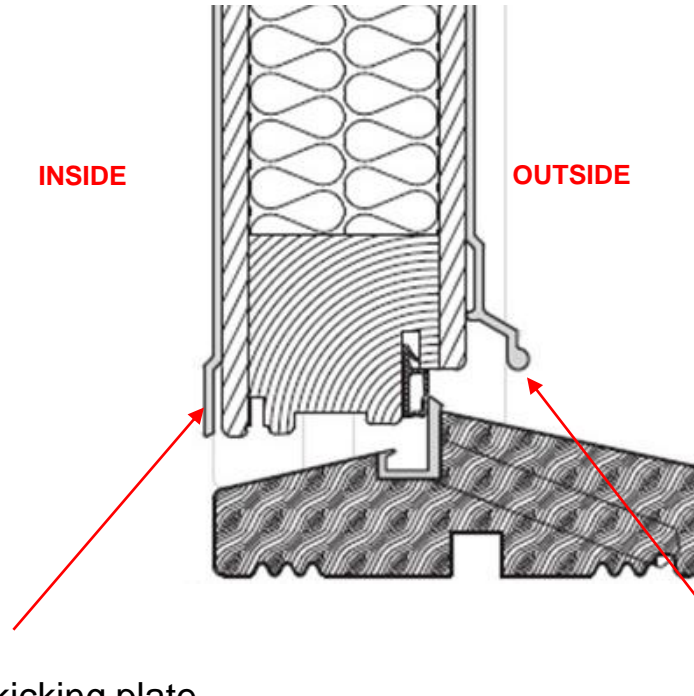

This type of kicking plate is only suitable for internal use, because the distance between the door facing and the alu plate is less than 5 mm.

This type of rain deflector is suitable on the external side of the door. The distance between the door facing and the alu plate is more than 5 mm.

Guidelines **Panels**

Surface treatment of MDF panels

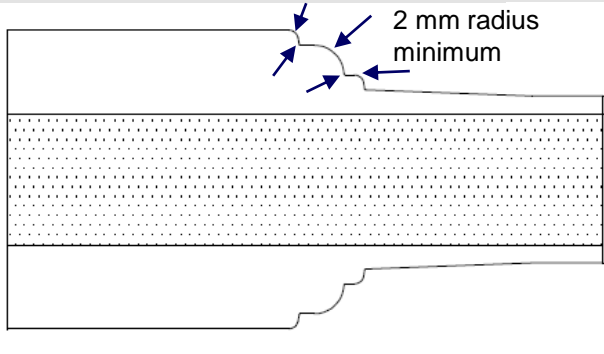

Installation of MDF panels

- Mdf panels must be fully sealed on all surfaces and edges with an exterior grade system to insure that the material does not absorb moisture. The recommended method of painting for both faces and edges is to seal (diffusion closed), prime and topcoat.
- The base coat should be done in several stages. The first layer of primer and sealer is applied to close the surface. Follow up with a pre-sanding (grain 240-320) to remove rough fibres in the surface without sanding through the sealer (be careful when sanding the edges and corners). The second layer of base coat is done to ensure uniform priming.
- On raised and fielded Mdf panels, it is important that prior to finishing of edges, the corners must be slightly rounded (2 mm radius minimum). Edges that are slightly rounded, rather than square and sharp, will hold paint better.
- Mdf panels shall be handled with caution. If the edges are damaged, either before or after the surface treatment, the panel should be scraped, because the gluing and binding of the fibres in the mdf panels often are destroyed further into the core of panel.
- Installation of mdf panels shall be carried out in such a way that the edges of the panels is not damaged and ensure ventilation and effective draining of moisture.
- Markings on the edge of the mdf panel with labels, tape or similar should be either on the side or top; never on the bottom.
- Installation of a door knocker, letter slot, decoration etc. where the painted surface will be opened, the nail/screw holes shall be sealed to prevent moisture entering.

- Installation of laminated solid timber panels in pine, oak and mahogany shall be carried out in such a way that it take in to account the expansion of the timber when moisture content and temperature changes.
- Ensure ventilation and sufficient air between the panel and the seam/sash on all four sides that can absorb the expansion of the laminated solid timber.
- Laminated solid timber panels in pine, oak and mahogany are recommended to be maximum 400 mm in the width when installed to avoid warping and bending.
- The laminated timber must be treated with an exterior grade system to insure that the material does not absorb moisture. Absorption of too much moisture will result in expansion of the laminated timber and result in delamination of the lamellas. Drying out of the laminated timber will also result in delamination of the lamellas.

Expansion in laminated solid timber: (pine, oak, mahogany)

Width: Changes in cross measure along growth rings is up to 0.3 %.

Height: Changes in length measure in fiber direction is limited to 0.01 %.

Calculation is based on:

Moisture content in laminated timber = 8 %

Expansion in pct per mm = 0.3 %

Width	Moisture content		
	10%	15%	18%
200 mm	1.2 mm	4.2 mm	6.0 mm
300 mm	1.8 mm	6.3 mm	9.0 mm
400 mm	2.4 mm	8.4 mm	12.0 mm
500 mm	3.0 mm	10.5 mm	15.0 mm

Storage and handling

- Laminated solid timber panels should be stored on a flat and level surface in a dry, well-ventilated building.
- Cover to keep clean and keep out sunlight, but allow air circulation.
- Handle with clean gloves and do not drag door blanks across one another or across other surfaces.
- Panels should not be subject to: abnormal heat, extreme dryness, humid conditions or sudden changes therein. They should be conditioned to average prevailing relative humidity of the locality before processing and hanging.
- For the best control of humidity to avoid warping and bending the laminated solid timber panels must always be wrapped in plastic. When the panel is unpacked always stack the panel on wood beddings or similar to secure ventilation around the panel.

Surface treatment

- Laminated solid timber panels must be treated with an exterior grade system to insure that the material does not absorb moisture. Absorption of too much moisture will result in expansion of the laminated timber and result in delamination of the lamellas.
- The recommended method of painting is to apply a uniform layer of paint on both sides in the same process to control the moisture content and to avoid warping and bending.
- To avoid black discoloration on oak only use acid proof stainless screws/nails. Installation of a door knocker, letter slot, decoration etc. where the painted surface will be opened, the nail/screw holes shall be sealed to prevent moisture entering.

Laminated solid timber panels

Laminated solid timber panels in pine, oak and mahogany are recommended to be maximum 400 mm in the width when installed to avoid warping and bending

MDF panels

Panels in MDF are suitable for most types and sizes of doors and are recommended to be used where larger panels are required. The stability of MDF panels are very much depended on correct installation and the overall construction of the door.

- Laminated solid timber panels are suitable
- MDF panels are suitable

- Laminated solid timber panels are **not suitable**
- MDF panels are suitable

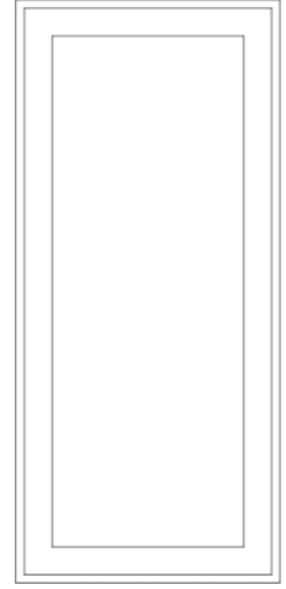
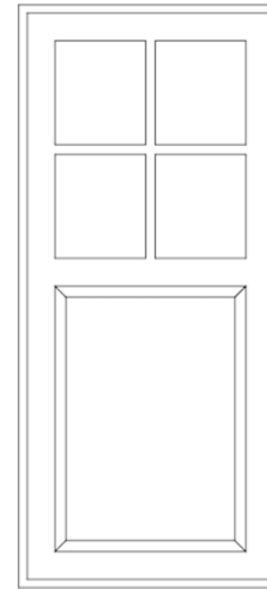
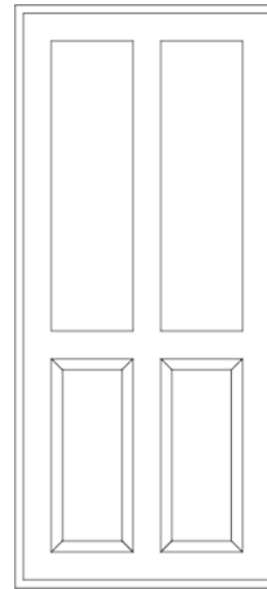
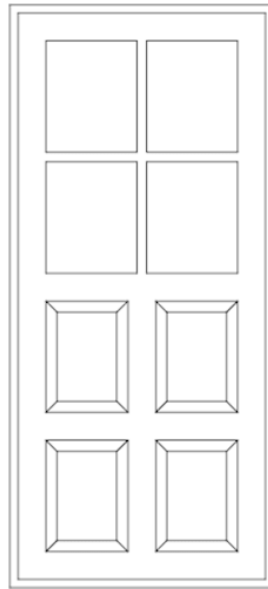

Surface treatment of MDF panels

2 mm radius
minimum

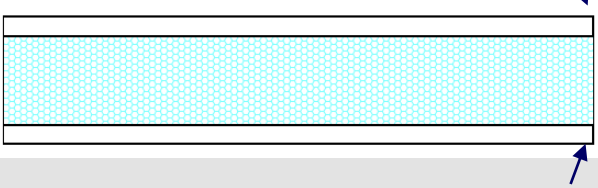

Installation of HDF panels

- Hdf panels must be fully sealed on all surfaces and edges with an exterior grade system to insure that the material does not absorb moisture. The recommended method of painting for both faces and edges is to seal (diffusion closed), prime and topcoat.
- The base coat should be done in several stages. The first layer of primer is applied to close the surface. Follow up with a pre-sanding (grain 240-320) to remove rough fibres in the surface. The second layer of base coat is done to ensure uniform priming.
- On hdf panels, it is important that prior to finishing of edges, the corners must be slightly rounded (2 mm radius minimum). Edges that are slightly rounded, rather than square and sharp, will hold paint better.
- Installation of hdf panels shall be carried out in such a way that the edges of the panels is not damaged and ensure ventilation and effective draining of moisture.
- Markings on the edge of the hdf panel with labels, tape or similar should be either on the side or top; never on the bottom.
- Installation of a door knocker, letter slot, decoration etc. where the painted surface will be opened, the nail/screw holes shall be sealed to prevent moisture entering.